

JEB Series

(Jump Eccentric Ball)

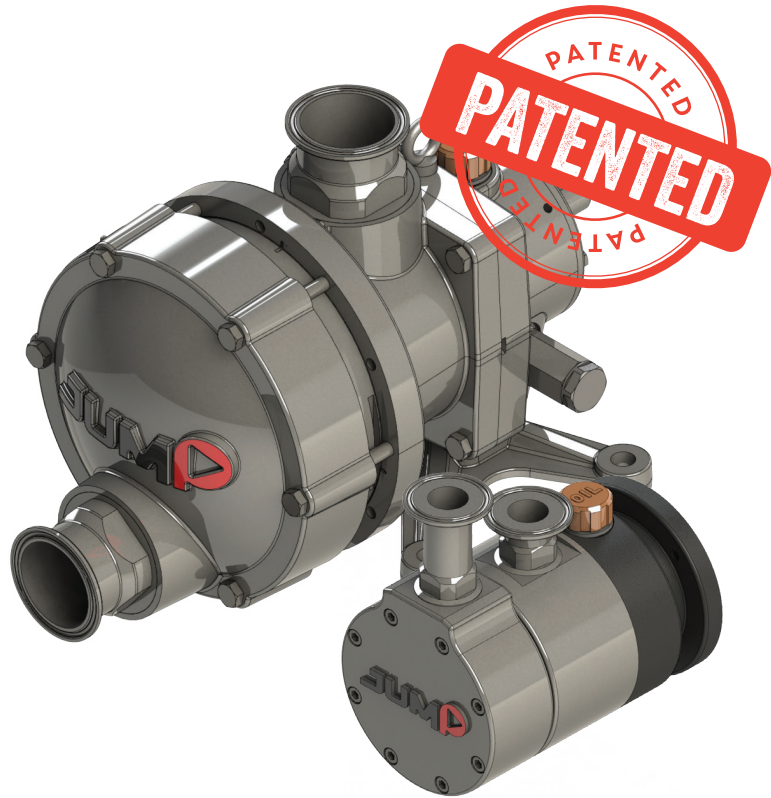

Sealless eccentric disc pump



Application areas

Wherever hygiene is essential and ideal for CIP / SIP applications



Food industry

Yoghurts and creams transfer, chocolate mousse, doughs, syrups, etc.



Cosmetics and pharmaceutical industries

Ointments and lotions transfer, toothpaste, lipstick, mascara, etc.



Chemical industry

Solvents transfer, polymers, acids, etc.

Operation principle

A shaft drives a piston inside a cylinder. The eccentric movement creates two pumping chambers allowing the transfer of the fluid from suction to discharge port. The sealing system is done by a set of ball joints coated by an elastomer sleeve to avoid any retention zones in the pump.

Characteristics

		Size 1 - DN20					Size 2 - DN50	
		JEB01	JEB02	JEB05	JEB08	JEB1.1	JEB1	JEB3
Pumping technology		Eccentric disc						
Sealing technology		Set of ball joints coated by an elastomer sleeve						
Cylinder capacity	L	0.0023	0.0045	0.0095	0.0150	0.0188	0,020	0,053
Speed (max.)	Rpm	1000	1000	1000	1000	1000	1000	1000
Flowrate (max.)	m ³ /h	0.1	0.2	0.5	0.8	1.1	1	3
Differential pressure (max.)	bar	10						
Minimum operating temperature	°C	-5						
Maximum operating temperature	°C	120 (standard version, for higher temperature, please contact us)						
Weight	Kg	13	13	13	13	13	31	33
Dimensions	mm L	180	180	184	188	192	368	373
	I	120	120	120	120	120	220	220
	H	154	154	154	154	154	232	232
	A	65	65	65	65	65	105	105
ATEX		Yes						

Dimensions

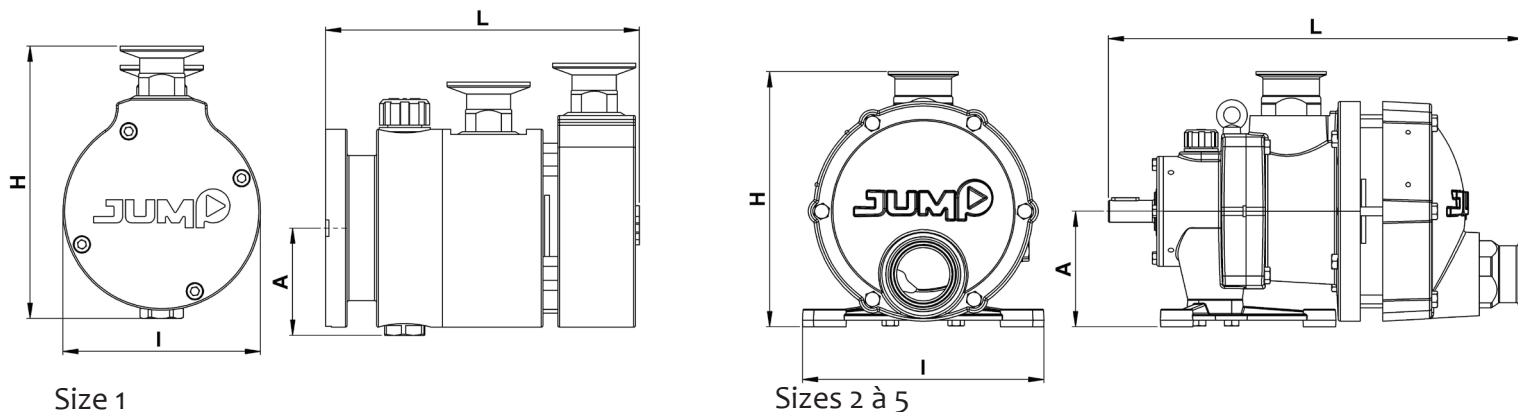

Materials

	JEBc «Ductile iron»	JEBs «316L Stainless steel»
Piston	Ductile iron	Jumplnox (Option: Bronze)
Cylinder	Ductile iron	316L Stainless Steel
Body / Front cover / Foot	Ductile iron	316L Stainless Steel
Seals	FKM (option FEP/FKM, EPDM...)	
Ball seal	FKM FDA (option FKM Chemical grade)	
Screws	Steel	Stainless steel

Options

- Fitting flanges ISO PN16 or PN20, Clamp, SMS, MACON, RJT, CAM-Lock, DIN, threaded...
- Heating jacket
- Opened front cover, with glass, sanitary drain valve
- External bypass

50	Size 3 - DN65			Size 4 - DN80			Size 5 - DN100		
JEB5	JEB6	JEB9	JEB12	JEB16	JEB20	JEB24	JEB30	JEB36	JEB42
0,086	0,16	0,24	0,33	0,53	0,65	0,78	1,19	1,38	1,57
1000	650	650	650	550	550	550	450	450	450
5	6	9	12	16	20	24	30	36	42
35	71	73	75	127	131	136	185	190	195
378	470	480	490	650	660	670	696	706	716
220	275	275	275	340	340	340	400	400	400
232	295	295	295	360	360	360	402	402	402
105	140	140	140	165	165	165	185	185	185

Illustrations

The +

Very low shear rate

Self priming

Dry run capabilities

Strong suction and
compression power

Hygienic: Innovative sealing
system without mechanical
seal and without retention
zones

CIP /SIP until 10 bar



JEB5s on stationary base plate



JEB1.1s on mobile trolley

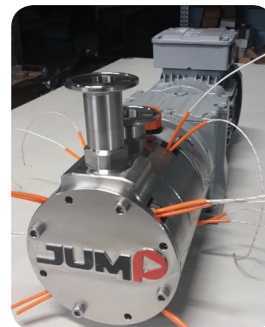

JEB1.1s with casing and
heating resistors



JEB1.1s with glass
front cover and drain
valve