



**Pompe centrifughe autoadescanti**  
**Self-priming centrifugal pumps**  
**Bombas centrífugas autocebantes**





## APPLICAZIONI / APPLICATIONS / APLICACIONES

### INDUSTRIA

- **Travaso:** liquidi limpidi, torbidi, sabbiosi, fangosi, neutri, alcalini, acidi; idrocarburi a bassa viscosità, solventi, anche se sporchi; latte di calce, soda; lavaggio, raffreddamento, circolazione, abbattimento fumi
- **Depurazione:** sollevamento acque di scarico anche se inquinate, calde, sabbiose, fangose, corrosive o contenenti corpi solidi; dosatura liquidi neutralizzanti; evacuazione od estrazione di fanghi da decantazione
- **Navale:** trasferimento, prosciugamento sentina, lavaggio, antincendio, strappaggio, evacuazione scarichi e circolazione
- **Agricoltura:** irrigazione a scorrimento; ossigenazione liquami; travaso e spargimento liquami o fertilizzanti liquidi; distribuzione mangimi liquidi; travaso mosti; lavaggio.

### INGEGNERIA CIVILE

- **Prosciugamento** di scavi, canali, bacini
- **Abbassamento di falda** mediante pozzi drenanti
- **Approvvigionamento idrico** da pozzi o canali
- **Lavaggio** getti di calcestruzzo e inerti
- **Pompaggio** di bentonite e fanghi di perforazione.

### SICUREZZA

- **Prosciugamenti** a seguito di alluvioni od allagamenti
- **Servizi d'emergenza:** sollevamento fognature temporaneo; antincendio; recupero liquidi pericolosi.

### INDUSTRY

- **Transfer:** clean, dirty, containing sand in suspension, muddy, neutral, alkaline, acidic liquids; low viscous petroleum products, solvents even if dirty; milk of lime, caustic soda; washing, cooling, recirculation, smoke scrubbing
- **Treatment:** pumping polluted, hot or corrosive waste water containing sand, mud or solids in suspension; dosing neutralising liquids; pumping out settled sludge
- **Naval:** loading and unloading; bilge pumping; washing, fire-fighting, stripping, sanitary duty and circulation
- **Agriculture:** surface irrigation; liquid manure oxygenation; transfer and spraying liquid manure or fertilisers; distribution of liquid animal feed; transfer of must; washing.

### CIVIL ENGINEERING

- **Drainage** of excavations, canals or ponds
- **Ground water dewatering** with drains
- **Water supply** from wells or canals
- **Washing** concrete castings and aggregate
- **Recirculation** of bentonite and drilling mud.

### SAFETY

- **Drainage** after flooding or terrenal rains
- **Emergency duty:** temporary sewage pumping; fire fighting; recovery of dangerous liquids.

### INDUSTRIA

- **Trasiego:** líquidos límpidos, turbios, arenosos, lodosos, neutros, alcalinos, ácidos; hidrocarburos de viscosidad baja, disolventes, también sucios; lechada de cal, sosa; lavado, refrigeración, circulación, eliminación de humos
- **Depuración:** elevación de aguas residuales incluso contaminadas, calientes, arenosas, lodosas, corrosivas o con sólidos; dosificación de líquidos neutralizantes; evacuación o extracción de lodos de decantación.
- **Naval:** trasiego, achique, lavado, contra incendio, drenaje, evacuación desagües y circulación
- **Agricultura:** riego por inundación; oxigenación de aguas residuales; trasiego por aspersion de estiércol o abonos; distribución de alimentos líquidos; trasiego de mostos; lavado.

### INGENIERÍA CIVIL

- **Drenaje** de excavaciones, canales, cuencas
- **Reducción del nivel de agua** mediante pozos drenantes
- **Abastecimiento hídrico** de pozos o canales
- **Lavado** colada de hormigón y áridos
- **Bombeo** de bentonita y lodos de perforación.

### SEGURIDAD

- **Drenajes** después de aluviones o inundaciones
- **Servicios de emergencia:** elevación momentánea en alcantarillados; lucha contra incendio; recuperación de líquidos peligrosos.



Lavori di conservazione a Venezia  
Restoration work at Venice  
Trabajos de conservación en Venecia

### Come funziona l'autoinnescamento

L'aria (freccette gialle) viene aspirata all'interno della pompa dalla depressione creata dalla girante in movimento e si emulsiona col liquido (freccette blu) contenuto nel corpo pompa.

L'emulsione aria-liquido viene spinta nella camera d'innescamento dove l'aria, più leggera, si separa ed esce dal tubo di mandata; il liquido, più pesante, ricade e torna in circolazione. Espulsa tutta l'aria dal condotto di aspirazione, la pompa s'innescerà e funzionerà come una normale pompa centrifuga. La pompa può funzionare anche con miscela aria-liquido.

La valvola di non ritorno ha una duplice funzione: evita lo svuotamento del tubo di aspirazione quando la pompa non è in funzione; nel caso accidentale di svuotamento del tubo di aspirazione trattiene, nel corpo pompa, una quantità di liquido sufficiente per l'innescamento.

La tubazione di mandata deve essere libera di scaricare l'aria proveniente dall'aspirazione.

### Cómo funciona la autoaspiración

El aire (flechas amarillas) es aspirado dentro de la bomba por el vacío creado por el impulsor en movimiento y se mezcla con el líquido (flechas azules) contenido en el cuerpo de la bomba.

La mezcla aire-líquido se empuja hacia la cámara de cebado donde el aire, más ligero, se separa y sale por el tubo de impulsión; el líquido, más pesado, cae de nuevo y vuelve a circular.

Una vez expulsado todo el aire por el conducto de aspiración, la bomba se cebará y funcionará como una bomba centrifuga normal. La bomba puede funcionar también con mezcla aire-líquido.

La válvula antirretorno tiene una doble función: evita que el tubo de aspiración se vacíe cuando la bomba no está funcionando; si el tubo de aspiración se vaciara accidentalmente, retiene en el cuerpo de la bomba una cantidad de líquido adecuada para el cebado.

La tubería de impulsión debe descargar libremente el aire que procede de la aspiración.

### Self-priming principle

The air (yellow arrows) is drawn into the pump due to the negative pressure created by the moving impeller and is emulsified with the liquid (blue arrows) contained in the pump casing.

The air-liquid emulsion is forced into the priming chamber where the lighter air is separated and leaves through the discharge pipe; the heavier liquid drops back down into circulation. Once all of the air has been expelled from the suction pipe, the pump is primed and works like a normal centrifugal pump. The pump can also work with an air-liquid mixture.

The non-return valve has a dual function: it prevents the suction pipe from emptying when the pump is off; in the event of accidental emptying of the suction pipe, this holds a sufficient amount of liquid in the pump casing to prime the pump.

The discharge pipe must be free to expel the air coming from the suction pipe.

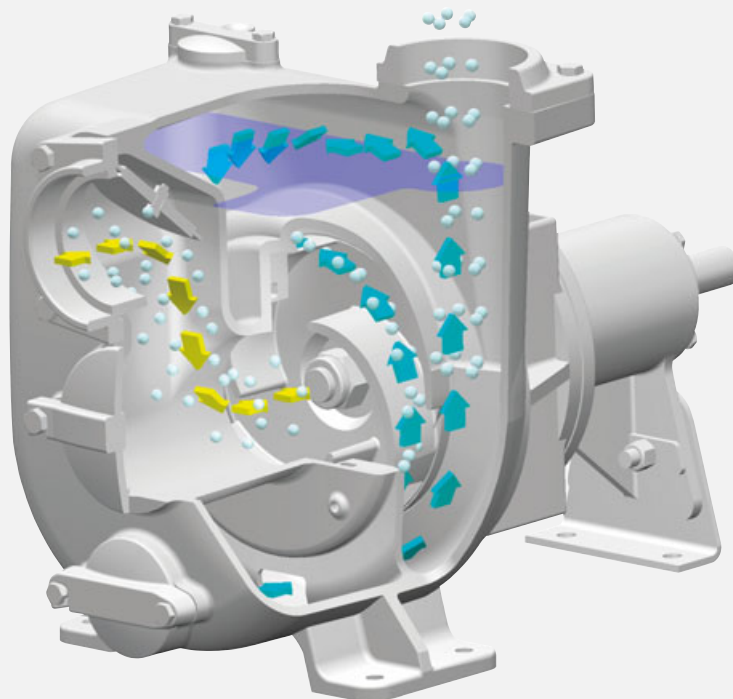

## VANTAGGI / BENEFITS / VENTAJAS

- **Rapido autoinnescamento**  
senza valvola di fondo. Una volta riempita d'acqua la pompa s'innescerà automaticamente fino ad una altezza di 7,5 m
- **Rapido self-priming**  
without foot valve. Once filled with water, the pump is automatically primed to a height of 7,5 m
- **Cebado automático rápido**  
sin válvula de pie. Una vez llena de agua la bomba se cebará automáticamente hasta una altura de 7,5 m
- **Girante aperta con passaggio di corpi solidi di grande diametro, facilmente ispezionabile**
- **Open impeller** allowing the passage of wide solid bodies and easy inspection
- **Rotor abierto con paso de sólidos de diámetro grande, fácil de inspeccionar**
- **Alta resistenza ai liquidi abrasivi:**  
il piatto d'usura è facilmente sostituibile.
- **High resistance to abrasive liquids:**  
the wear plate is easily replaceable.
- **Alta resistencia a los líquidos abrasivos:**  
el disco de desgaste es fácil de sustituir.
- **Tenuta assiale meccanica lubrificata dall'esterno:**  
nessuna perdita o infiltrazione d'aria lungo l'albero.
- **Axial mechanical seal lubricated from the outside:**  
no leaks or infiltration of air along the shaft.
- **Cierre mecánico axial lubricado desde afuera:**  
ninguna pérdida o filtración de aire a lo largo del eje.
- **Facilità di installazione:**  
solo il tubo di aspirazione va immerso nel liquido. La pompa può essere collocata in alto e all'asciutto, nel posto più adatto per la manutenzione ed il controllo.
- **Easy to install:**  
only the suction pipe needs to be immersed in the liquid. The pump can be located above and in a dry place, in the most suitable location for service and control.
- **Facilidad de instalación:**  
solo el tubo de aspiración debe sumergirse en el líquido. La bomba puede colocarse a altura y en seco, en el lugar más adecuado para el mantenimiento y control.
- **Lunga durata:**  
le parti soggette ad usura sono facilmente sostituibili, anche più volte, riportando la pompa alle sue prestazioni originali.
- **Long life:**  
the parts subject to wear can be easily replaced, several times, restoring the original performance of the pump.
- **Larga duración:**  
las piezas sujetas a desgaste son fáciles de sustituir, incluso varias veces, restableciendo las prestaciones originales de la bomba.

## CARATTERISTICHE / FEATURES / CARACTERÍSTICAS

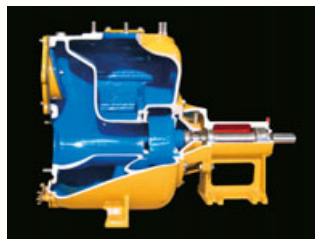

- Corpo robusto in ghisa, bronzo o acciaio inossidabile.
- Portine di riempimento, svuotamento e ispezione\* girante facilmente apribili. (\* Non disponibile nei modelli J 1-160 / 2-100 / 3-100 / 4-100)
- Heavy duty casing in cast iron, bronze or stainless steel.
- Easily opened priming, drain and impeller inspection\* covers. (\* Not available for J 1-160 / 2-100 / 3-100 / 4-100 models)
- Cuerpo robusto de fundición, bronce o acero inoxidable.
- Tapas de llenado, vaciado e inspección\* del rotor fáciles de abrir. (\* No es disponible en los modelos J 1-160 / 2-100 / 3-100 / 4-100)

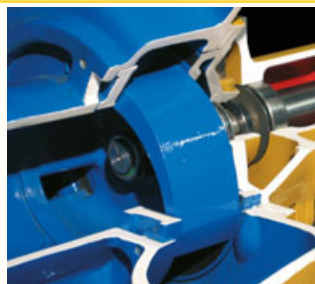

- Girante aperta in ghisa sferoidale, bronzo all'alluminio o acciaio inossidabile con grande passaggio di corpi solidi.
- Ductile iron, aluminium bronze or stainless steel open impeller handling large diameter spherical solids.
- Impulsor abierto de fundición esferoidal, bronce al aluminio o acero inoxidable con paso grande para sólidos.

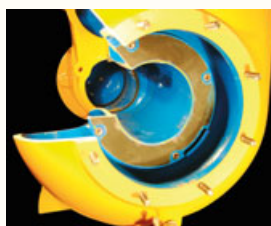

- Piatto(i) di usura facilmente sostituibile(i), in ghisa, ghisa ricoperta di gomma antiabrasiva, bronzo o acciaio inossidabile. (Non disponibile nei modelli J 1-160 / 2-100 / 3-100 / 4-100)
- Easily replaced cast iron, abrasion resistant rubber faced cast iron, bronze or stainless steel wear plate(s). (Not available for J 1-160 / 2-100 / 3-100 / 4-100 models)
- Disco(s) de desgaste fáciles de sustituir, de fundición, fundición revestida de goma antiabrasiva, bronce o acero inoxidable. (No es disponible en los modelos J 1-160 / 2-100 / 3-100 / 4-100)

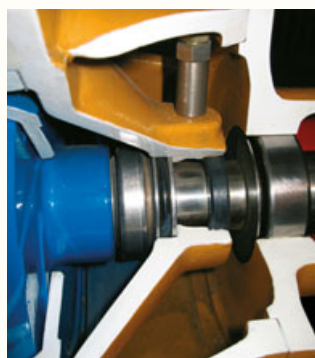

- Tenuta assiale meccanica lubrificata dall'esterno. Può funzionare a secco raggiungendo il vuoto massimo, anche in presenza di liquidi fortemente abrasivi.
- Controfacce in carburo di silicio o di tungsteno (faccia rotante in grafite per versioni per carburanti).
- Su richiesta, tenuta doppia o a cartuccia.
- Externally lubricated mechanical seal. Can run dry on high vacuum even when pumping highly abrasive liquids.
- Silicon or tungsten carbide seats (graphite rotating seat for versions for petroleum products).
- On request, double or cartridge seals.
- Cierre mecánico axial lubricado desde afuera. Puede funcionar en seco alcanzando el vacío máximo, también con líquidos muy abrasivos.
- Contracaras de carburo de silicio o de tungsteno (cara giratoria de grafito para versiones para combustibles).
- Bajo pedido, cierre doble o de cartucho.



- Supporto con cuscinetti di grandi dimensioni per azionamento anche a mezzo di cinghie trapezoidali.
- Estremità d'albero forata e filettata per facilitare il montaggio di giunti o pulegge.
- Bearing housing with heavy duty bearings suitable for direct or V-belt drive.
- Standard diameter shaft extension bored and tapped to facilitate the assembly of couplings or pulleys.
- Soporte con cojinetes de tamaño grande para accionamiento también mediante correas trapezoidales.
- Extremo del eje perforado y roscado para facilitar el montaje de uniones o poleas.

## AZIONAMENTI / DRIVE / ACCIONAMIENTOS

**JS**



- Albero Libero
- Bare shaft
- Eje libre

**JP**



- Preassemblata per accoppiamento monoblocco
- Pre-assembled for close-coupling
- Premontada para acoplamiento monobloque

**JE**



- Motore elettrico
- Electric motor
- Motor eléctrico

**JX**



- Gruppo ATEX II 2/2G
- II 2/2D (JE/JP monoblocco)
- ATEX Unit II 2/2G
- II 2/2D (JE/JP close-coupled)
- Grupo ATEX II 2/2G
- II 2/2D (JE/JP monobloque)

**JB**



- Motore a benzina
- Gasoline engine
- Motor a gasolina

**JD**



- Motore diesel
- Diesel engine
- Motor diesel

**JO**



- Motore oleodinamico
- Hydraulic motor
- Motor hidráulico

**JT**



- Turbina idraulica
- Water turbine
- Turbina hidráulica

## ALLESTIMENTI / ARRANGEMENTS / EQUIPAMIENTOS

### LIGHT



- Maniglia
- Handle
- Empuñadura

### LIFT



- Barella portatile
- Carrying frame
- Angarilla portátil

### BASE



- Base
- Base plate
- Base

### TROLLEY



- Carrello servizio leggero
- Trolley
- Carro servicio simple

### TRAILER



- Carrello servizio pesante
- Heavy duty site trailer
- Carro servicio pesado

### TANK



- Base servizio pesante
- Heavy duty base plate
- Base servizio pesado

### BLOCK



- Base servizio pesante per carrello stradale
- Heavy duty base plate for road trailer
- Base servicio pesado por carro de carretera

### ROAD



- Carrello stradale
- Road trailer
- Carro de carretera

### SKID



- Slitta
- Skid
- Carro rodante

## ALLESTIMENTI SPECIALI / SPECIAL ARRANGEMENTS / EQUIPAMIENTOS ESPECIALES

### RANGER



- Carrello servizio pesante con 4 ruote
- Heavy duty site trailer with 4 wheels
- Carro servicio pesado con 4 ruedas

### BULL



- Slitta con protezione tubolare
- Skid with tubular protection
- Carro rodante con protección tubular

### RALLY



- Carrello servizio pesante con protezione tubolare
- Heavy duty site trailer with tubular protection frame
- Carro servicio pesado con protección tubular

### STACK



- Gruppo impilabile e serbatoio maggiorato
- Stackable unit and oversized tank
- Grupo apilable y tanque aumentado

#### Note / Notes / Notas:

- **Allestimenti servizio leggero:** con serbatoio sul motore.
- **Light duty arrangements:** with fuel tank mounted on the engine.
- **Equipamientos servicio simple:** con tanque en el motor.
- **Allestimenti servizio pesante:** con serbatoio integrato nel telaio, punto di sollevamento baricentrico.
- **Heavy duty arrangements:** with fuel tank incorporated into the chassis, barycentric lifting point.
- **Equipamientos servicio pesado:** con tanque integrado en el telar, punto de levantamiento baricéntrico.



Drenaggio scavi per posa metanodotto  
Drainage excavation for pipeline installation  
Drenaje de las excavaciones para puesta metanoducto

## VERSIONI / VERSIONS / VERSIONES

### VUOTOASSISTITE / VACUUM-ASSISTED / CON BOMBA DE VACÍO

#### ECOMATIC



- Depressore lubrificato con sistema di ricircolo d'olio
- Lubricated vacuum pump with oil recirculation system
- Bomba de vacío lubricada con sistema de recirculación de aceite

#### SIMPLE



- Depressore lubrificato ad olio
- Oil lubricated vacuum pump
- Bomba de vacío lubricada por aceite

#### DUO



- Depressore a camme senza lubrificazione
- Rotary claw vacuum pump without lubrication
- Bomba de vacío de uñas sin lubricación

### SILENZIATE / SILENCED / INSONORIZADAS

#### SILENT



- Motore silenziato
- Silenced engine
- Motor insonorizado

#### MUTELINE



J 6-250

- Cabina silenziata 71 dB(A) - livello di pressione sonora (LPA) a 7 metri

#### MELODY



- Cabina super-silenziata 60 dB(A) - livello di pressione sonora (LPA) a 7 metri
- Super-silenced canopy 60 dB(A) - Sound pressure level (LPA) at 7 meters
- Cabina super-insonorizada 60 dB(A) - Nivel de presión sonora (LPA) a 7 metros



J 12-400

- Silenced canopy 71 dB(A) - Sound pressure level (LPA) at 7 meters
- Cabina insonorizada 71 dB(A) - Nivel de presión sonora (LPA) a 7 metros



## JETTING



- Versione per l'infissione di punte filtranti wellpoint
- Version for installing wellpoint
- Versión para instalacion wellpoint

## GRINDER



- Versione con coltelli trituratori
- Version with cutting device
- Versión con cuchillos trituradores



## SAXMAG



- Versione con trascinamento magnetico
- Version with magnetic-drive
- Versión con arrastre magnético



Drenaggio di zona allagata  
Drainage of flooded area  
Drenaje de lugar inundado



# J

## Pompe centrifughe autoadescenti Self-priming centrifugal pumps Bombas centrífugas autocebantes

### Elettropompe / Electrically-driven pumps / Electrobombas

Modello Model Modelo		Bocche Ports Bocas		Solidi Solids Sólidos	50 HZ							60 HZ								
					Portata Capacity Caudal			Prevalenza Head Altura de elev.			Velocità Speed Velocidad	Potenza Power Potencia	Portata Capacity Caudal			Prevalenza Head Altura de elev.			Velocità Speed Velocidad	Potenza Power Potencia
Nuovo New Nuevo	Vecchio Old Viejo	mm	in	mm	m³/h			m			rpm	kW	m³/h			m			rpm	kW
J 1-110 *	J 40	40	1 ½"	20	22	15	5	5,5	11	15	2900	1,1	24	15	5	5	18	21,5	3450	2,2
J 1-160 *	E 30-160 ■	40	1 ½"	8	20	12	5	10	24	27	2900	2,2	21	13	5	12	35	39	3450	4
J 1-180 *		40	1 ½"	11	25	15	6	22	32	34	2900	4	25	15	6	34	48	48	3450	5,5
J 2-100 *	E 50 ■	50	2"	17	30	20	8	2	8	13	2900	1,1	32	20	8	5	13	18	3450	2,2
J 2-120 *	J 50	50	2"	25	44	30	10	5	12	18	2900	2,2	48	30	10	9,5	20	25	3450	4
J 2-170 *		50	2"	13	44	30	10	14	22	31	2900	4	48	30	10	22	37	47	3450	7,5
J 2-180 *		50	2"	15	50	30	10	20	30	34	2900	5,5	50	30	10	34	44	48	3450	11
J 2-215 *		50	2"	14	46	25	10	42	52	57	2900	11	46	25	10	66	76	82	3450	18,5
J 2-220	J 60-220	50	2"	12	42	28	10	42	52	58	2900	11	-	-	-	-	-	-	-	-
J 3-100 *	E 75 ■	80	3"	25	60	37	15	4	9	12	2900	2,2	70	43	15	5	13	17	3450	3
J 3-140 *		80	3"	28	70	40	20	13	18	20	2900	4	70	40	20	21	26	28,5	3450	7,5
J 3-180 *		80	3"	27	85	50	20	18	29	34	2900	7,5	85	50	20	34	45	48	3450	15
J 3-225		80	3"	23	80	50	20	40	48	53	2900	15	-	-	-	-	-	-	-	-
J 3-240 *		80	3"	14	80	40	20	32	60	64	2900	18,5	80	40	20	64	86	90	3450	30
J 3-250	J 70-250	80	3"	12	65	42	15	45	60	67	2900	18,5	-	-	-	-	-	-	-	-
J 3-252		80	3"	14	95	60	20	51	65	72	2900	22	95	60	20	80	95	103	3450	37
J 3-305		80	3"	20	105	70	30	96	106	108	2900	55	-	-	-	-	-	-	-	-
J 4-100 *	E 100 ■	100	4"	38	100	65	25	5	9	13	2900	4	120	75	30	6	14	18	3450	7,5
J 4-159	J 90-2	100	4"	45	155	100	40	13	26	26	2900	15	-	-	-	-	-	-	-	-
J 4-160 *	J 90-4	100	4"	45	155	100	40	12	22	24	2900	11	-	-	-	-	-	-	-	-
J 3-210 *	J 85	80	3"	40	80	45	20	7	13	15	1450	4	90	45	20	12	19,5	22	1750	7,5
J 4-250 *		100	4"	50	160	100	40	5	13	18	1450	7,5	160	100	40	11	22	26,5	1750	15
J 4-253 *	J 4-250W	100	4"	45	150	100	40	9	15	19	1450	7,5	150	100	40	18	24	28	1750	15
J 4-316		100	4"	38	180	110	60	16	26	29	1450	18,5	180	110	60	30	40	43	1750	30
J 6-250 *		150	6"	76	300	200	80	5	11	15	1450	11	340	200	80	8	18	22	1750	22
J 6-253 *	J 6-250W	150	6"	45	300	200	80	4	10	14	1450	11	340	200	80	8	17	20	1750	18,5
J 6-350		150	6"	37	300	180	80	19	30	33	1450	30	-	-	-	-	-	-	-	-
J 6-355		150	6"	47	330	200	90	14	26	32	1450	30	-	-	-	-	-	-	-	-
J 6-400		150	6"	50	380	200	80	18	36	38	1450	45	380	200	100	42	54	55	1750	75
J 8-300		200	8"	60	480	320	120	8	15	20	1450	22	480	320	120	15	25	28,5	1750	45
J 8-305		200	8"	76	420	200	100	5	13	17	1450	18,5	480	200	100	10	20	27	1750	30
J 10-305		250	10"	76	600	400	200	6	15	18,5	1450	30	600	400	200	17	23,5	28	1750	45
J 6-350		150	6"	37	280	200	80	3	9	14	960	11	-	-	-	-	-	-	-	-
J 6-355		150	6"	47	225	150	75	5	10	14	960	11	280	200	80	7	14	20	1150	15
J 12-400	J 300	300	12"	70	1200	720	300	8	12	15	960	55	-	-	-	-	-	-	-	-

\* Monoblocco con motore a norma IEC 60034 (50 HZ).

\* Close-coupled with IEC 60034 standards motor (50 HZ).

\* Monobloque con motor según la norma IEC 60034 (50HZ).

■ Modello senza piatto d'usura.

■ Model without wear plate.

■ Modelo sin placa de desgaste.

PRESTAZIONI / PERFORMANCE / PRESTACIONES

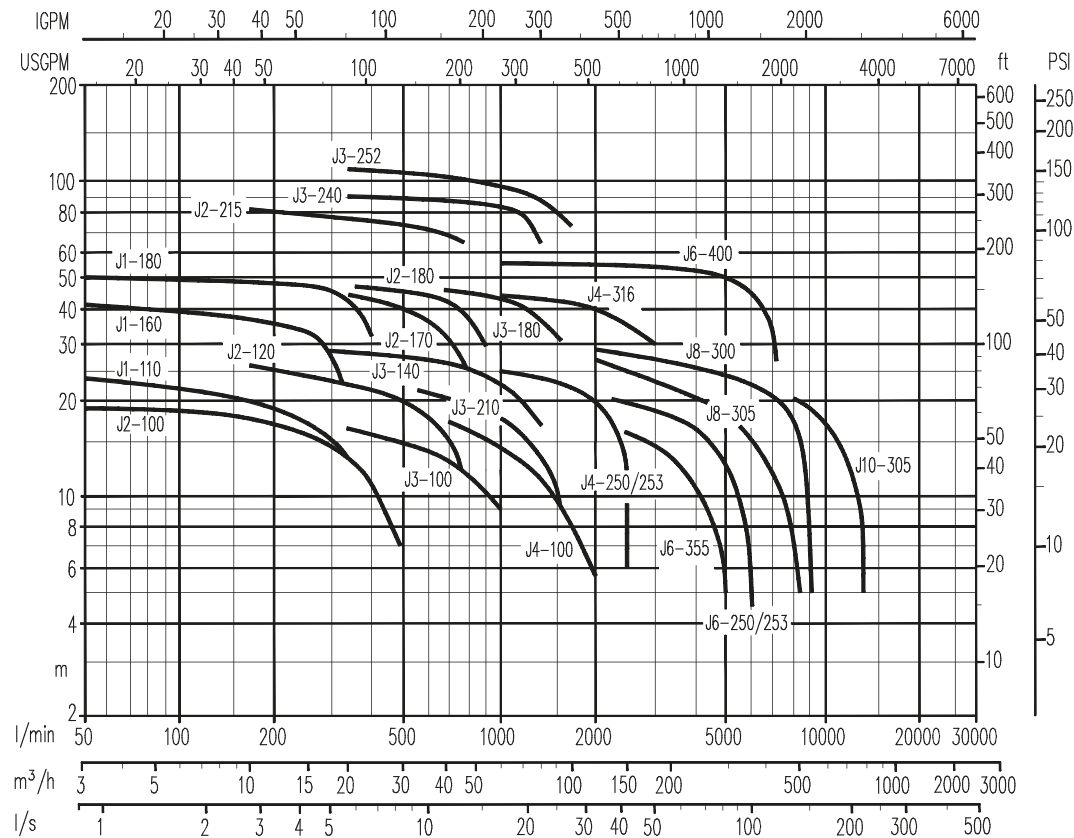
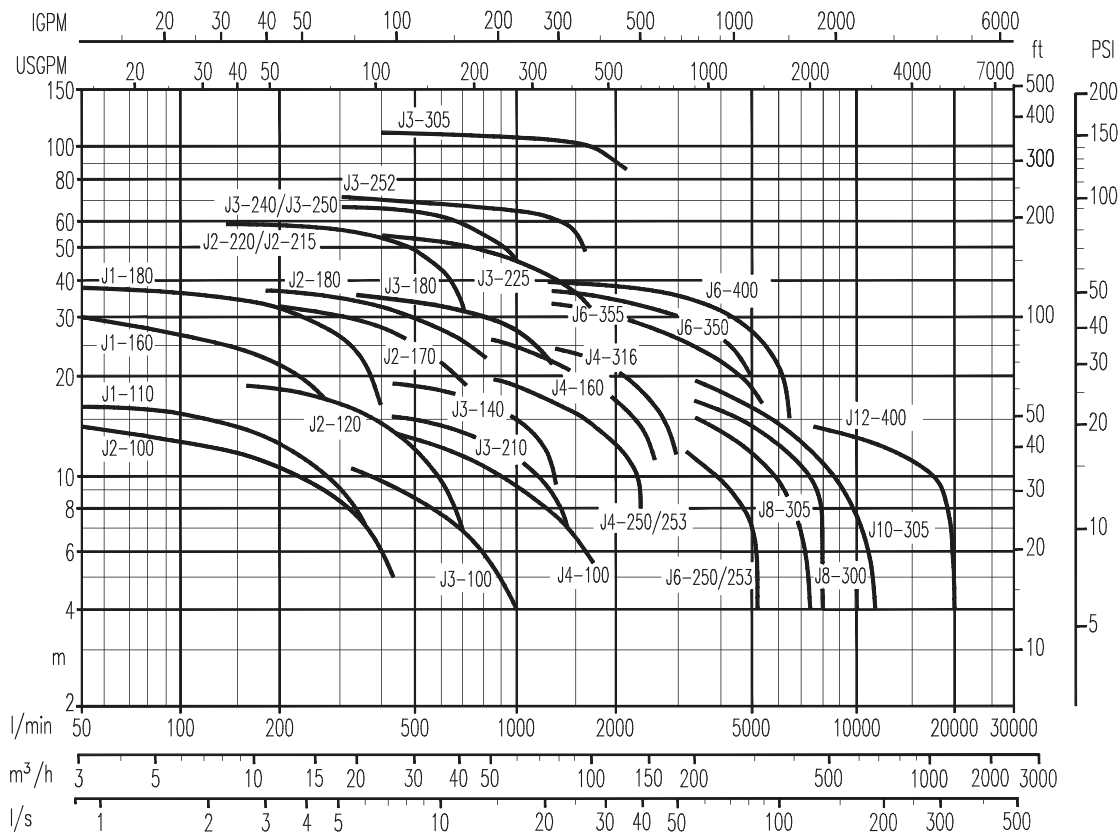

## Motopompe / Engine-driven pumps / Motobombas

Modello Model Modelo		Bocche Ports Bocas		Solida Sólidos Sólidos	Portata Capacity Caudal	Prevalenza Head Altura de elev.	Velocità Speed Velocidad	Potenza Power Potencia
Nuovo New Nuevo	Vecchio Old Viejo	mm	in	mm	m <sup>3</sup> /h	m	rpm	kW
J 1-110	J 40	40	1 ½"	20	25	25	3600	2,6
J 1-160	E 30-160 ■	40	1 ½"	8	22	48	3600	5,5
J 1-180		40	1 ½"	11	26	48	3200	5,3
J 2-100	E 50 ■	50	2"	17	36	22	3600	3
J 2-120	J 50	50	2"	25	48	28	3600	4,1
J 2-170		50	2"	13	50	36	3000	5,5
J 2-180		50	2"	15	50	40	3000	5,5
J 2-215		50	2"	14	46	60	3000	10,4
J 2-220	J 60-220	50	2"	12	41	60	3000	10,3
J 3-100	E 75 ■	80	3"	25	75	22	3600	5
J 3-140		80	3"	28	80	25	3000	5,5
J 3-180		80	3"	27	85	36	3000	10,4
J 3-225		80	3"	23	120	60	3000	24
J 3-240		80	3"	14	70	78	3000	26
J 3-250	J 70-250	80	3"	12	65	73	3000	24
J 3-305		80	3"	20	105	103	2800	48
J 4-100	E 100 ■	100	4"	38	130	24	3600	8
J 4-159	J 90-2	100	4"	45	170	23	2500	12
J 4-160	J 90-4	100	4"	45	160	21	2500	12
J 5-180	J 120-2	125	5"	60	230	17	2000	14
J 3-210	J 85	80	3"	40	90	25	1800	8,1
J 4-250		100	4"	50	160	32	1800	20
J 4-253	J 4-250W	100	4"	45	150	29	1800	20
J 4-316		100	4"	38	190	48	1800	41
J 6-250		150	6"	76	360	28	1800	22
J 6-253	J 6-250W	150	6"	45	340	23	1800	22
J 6-350		150	6"	37	330	40	1500	27,5
J 6-355		150	6"	47	340	37	1500	27,5
J 6-400		150	6"	50	400	62	1800	81
J 8-300		200	8"	60	550	30	1800	41
J 8-305		200	8"	76	530	28	1800	32
J 10-305		250	10"	76	750	25	1700	40
J 12-400	J 300	300	12"	70	1400	21	1150	110

■ Modello senza piatto d'usura.

■ Model without wear plate.

■ Modelo sin placa de desgaste.

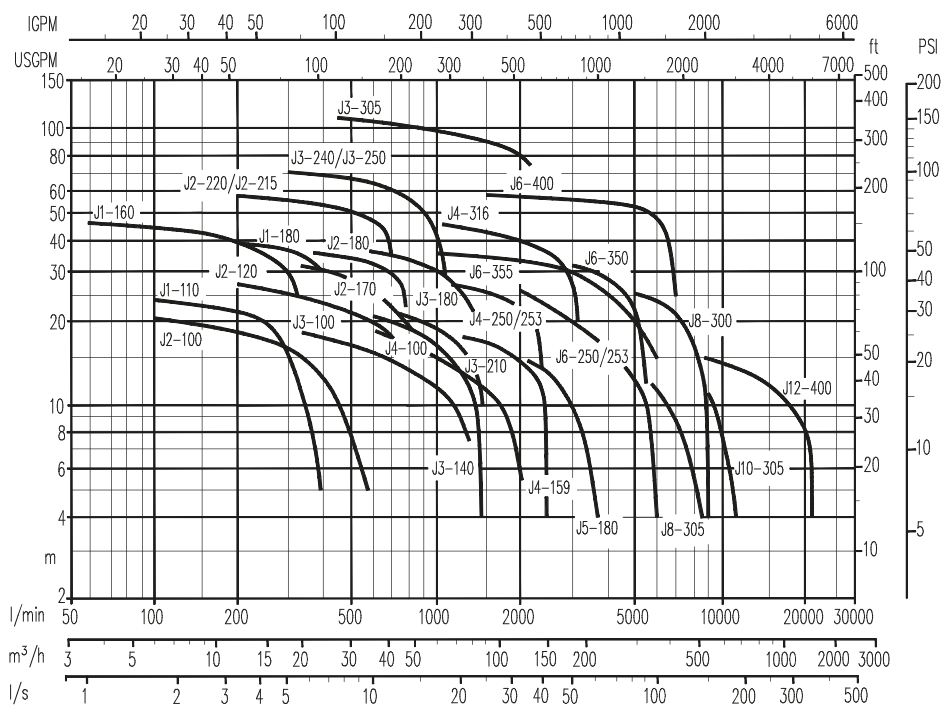

## DIMENSIONI E PESI / DIMENSIONS AND WEIGHTS / DIMENSIONES Y PESOS

### Albero libero / Bare shaft / Eje libre

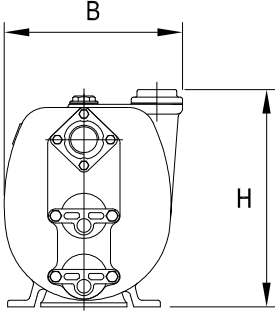
	Modello Model Modelo	Bocche Ports Bocas		B	H	L	D	Peso Weight Peso
		mm	in	mm	mm	mm	mm	kg
	<b>J 1-110</b>	40	1 ½"	171	227	364	19	15
	<b>J 1-110 K</b>	40	1 ½"	179	220	349	19	18
	<b>J 1-160</b>	40	1 ½"	241	279	383	19	22
	<b>J 1-180</b>	40	1 ½"	269	328	495	28	44
	<b>J 2-100</b>	50	2"	204	268	317	19	14
	<b>J 2-120</b>	50	2"	188	328	429	19	25
	<b>J 2-120 K</b>	50	2"	219	286	407	19	27
	<b>J 2-170</b>	50	2"	298	388	554	28	60
	<b>J 2-180</b>	50	2"	298	388	554	28	60
	<b>J 2-215</b>	50	2"	317	399	585	28	71
	<b>J 2-220</b>	50	2"	402	405	556	28	56
	<b>J 3-100</b>	80	3"	230	307	354	19	17
	<b>J 3-140</b>	80	3"	264	400	549	28	42
	<b>J 3-140 B</b>	80	3"	278	412	532	28	43
	<b>J 3-180</b>	80	3"	282	403	540	28	54
	<b>J 3-225</b>	80	3"	316	404	623	28	75
	<b>J 3-240</b>	80	3"	393	452	651	32	90
	<b>J 3-250</b>	80	3"	540	485	678	32	92
	<b>J 3-252</b>	80	3"	393	452	651	32	90
	<b>J 3-305</b>	80	3"	419	541	906	55	212
	<b>J 4-100</b>	100	4"	283	382	468	19	35
	<b>J 4-159</b>	100	4"	299	474	627	28	75
	<b>J 4-160</b>	100	4"	299	474	627	28	75
	<b>J 3-210</b>	80	3"	316	419	629	28	75
	<b>J 4-250</b>	100	4"	421	497	759	32	130
	<b>J 4-253</b>	100	4"	421	497	759	32	130
	<b>J 4-316</b>	100	4"	531	585	883	42	172
	<b>J 4-316 K</b>	100	4"	535	650	928	42	218
	<b>J 6-250</b>	150	6"	475	619	872	32	203
	<b>J 6-253</b>	150	6"	475	619	872	32	203
	<b>J 6-350</b>	150	6"	578	684	895	40	280
	<b>J 6-355</b>	150	6"	578	684	895	40	280
	<b>J 6-400</b>	150	6"	730	821	1095	55	406
	<b>J 8-300</b>	200	8"	591	734	1089	42	296
	<b>J 8-305</b>	200	8"	591	734	1089	42	296
	<b>J 10-305</b>	250	10"	758	942	1292	55	550
	<b>J 12-400</b>	300	12"	920	1200	1170	60	710

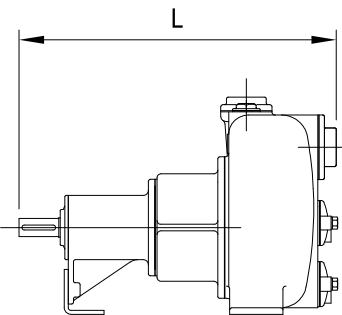
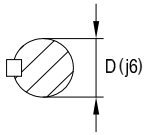
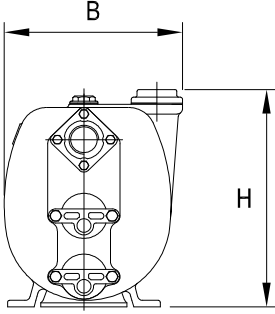

**Monoblocco con motore elettrico standard B34/B35 / Close-coupled to B34/B35 standard electric motor**  
**Monobloque con motor eléctrico estándar B34/B35**

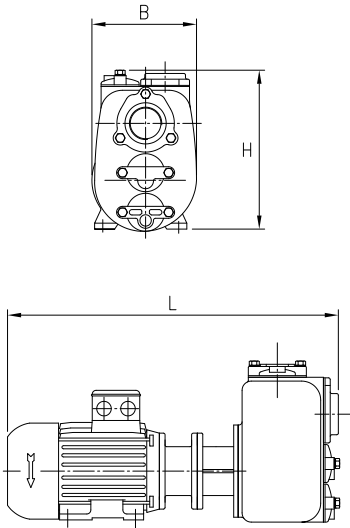
	Modelo Model Modelo	Bocche Ports Bocas		B mm	H mm	L mm	Peso Weight Peso kg
		mm	in				
	J 1-110	40	1 ½"	160	237	496	29
	J 1-160	40	1 ½"	241	287	584	39
	J 1-180	40	1 ½"	304	321	694	71
	J 2-100	50	2"	204	262	504	27
	J 2-120	50	2"	193	291	601	41
	J 2-170	50	2"	345	404	859	96
	J 2-180	50	2"	345	404	859	96
	J 2-215	50	2"	317	399	1020	200
	J 3-100	80	3"	230	307	603	37
	J 3-140	80	3"	305	384	754	75
	J 3-180	80	3"	282	403	861	107
	J 3-240	80	3"	393	452	1075	240
	J 4-160	100	4"	299	465	1047	191
	J 4-250	100	4"	421	490	981	186
	J 4-253	100	4"	421	490	981	186
	J 6-250	150	6"	475	590	1242	279
	J 6-253	150	6"	475	590	1242	279

**Motopompe / Engine driven pumps / Motobombas**

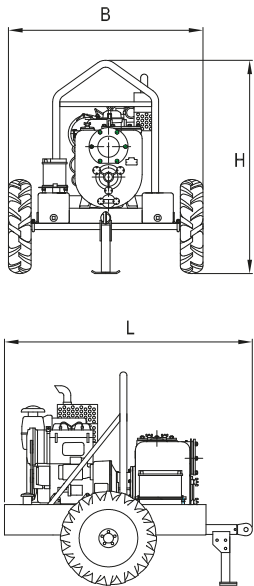
	Modelo Model Modelo	Bocche Ports Bocas		B mm	H mm	L mm	Peso Weight Peso kg
		mm	in				
	J 1-110	40	1 ½"	610	700	700	80
	J 1-160	40	1 ½"	610	675	870	60
	J 1-180	40	1 ½"	610	700	700	110
	J 2-100	50	2"	420	570	980	58
	J 2-120	50	2"	610	700	700	85
	J 2-170	50	2"	720	1100	920	125
	J 2-180	50	2"	720	1100	920	125
	J 2-215	50	2"	800	950	1250	220
	J 2-220	50	2"	800	950	1250	205
	J 3-100	80	3"	420	570	980	69
	J 3-140	80	3"	720	1100	920	130
	J 3-180	80	3"	780	1150	1090	160
	J 3-240	80	3"	960	1470	1710	450
	J 3-250	80	3"	960	1270	1735	370
	J 3-305	80	3"	1460	1500	1750	560
	J 4-100	100	4"	610	730	700	108
	J 4-159	100	4"	780	1170	1150	230
	J 5-180	125	5"	1468	1247	1450	345
	J 3-210	80	3"	780	1150	1270	270
	J 4-250	100	4"	1468	1605	1845	610
	J 4-253	100	4"	1468	1605	1845	610
	J 4-316	100	4"	1368	1490	2128	745
	J 6-250	150	6"	1368	1587	1753	710
	J 6-253	150	6"	1368	1587	1753	710
	J 6-350	150	6"	1460	1632	2528	955
	J 6-355	150	6"	1460	1632	2528	955
	J 6-400	150	6"	1604	1706	2828	1450
	J 8-300	200	8"	1468	1632	1853	920
	J 8-305	200	8"	1468	1632	1853	920
	J 10-305	250	10"	1604	1677	2933	1340
	J 12-400	300	12"	1814	1720	2933	2060

Dimensioni e pesi possono variare con la motorizzazione / Dimensions and weights depend on the engine / Las dimensiones y pesos pueden variar con la motorización

ALLESTIMENTI / ARRANGEMENTS / EQUIPAMIENTOS



JD 12-400 TRAILER



SIMPLE JD 8-300



DUO JE 6-253



ECOMATIC JD 4-250



JE 4-160 TROLLEY



JP 3-240 MOD

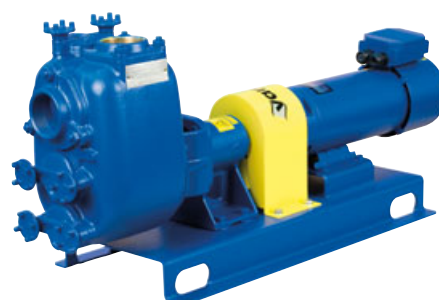

JE 2-120

## **VARISCO S.p.A.**

**variscopspa.com**

**Terza Strada, 9 - Z.I. Nord  
35129 PADOVA - Italy  
Tel. +39 049 82 94 111  
Fax +39 049 82 94 373**

**Vendite Italia  
Tel. 049 82 94 111  
Fax 049 82 94 373  
italia@variscopspa.com**

**International sales  
Tel. +39 049 82 94 111  
Fax +39 049 80 76 762  
export@variscopspa.com**

