

APPLICATIONS

Waste Treatment

Sludges, Sewage, Flocculants.

Food Processing

Live Fish, Fruits, Vegetables.

Pulp and Paper

Wood Chips, Medium Density Pulp
Stock, Sludges.

Chemical/Petrochemical

Oil/Water Separators, Crystal Slurries,
Non-Newtonian Slurries.

Mining

Carbon and Resin Slurries, Solvent Extraction.



DRIVE CONFIGURATIONS

In addition to the arrangements shown below, Hayward Gordon XCS Series pumps can be manufactured in custom configurations.

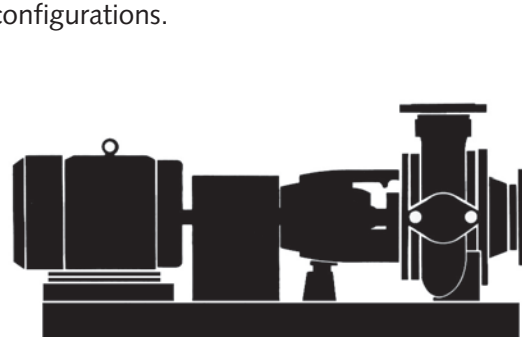

DIRECT DRIVE

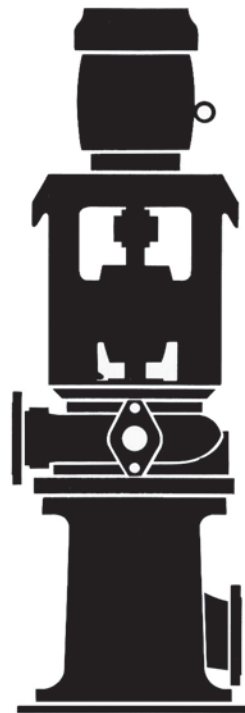

VERTICAL DRY PIT

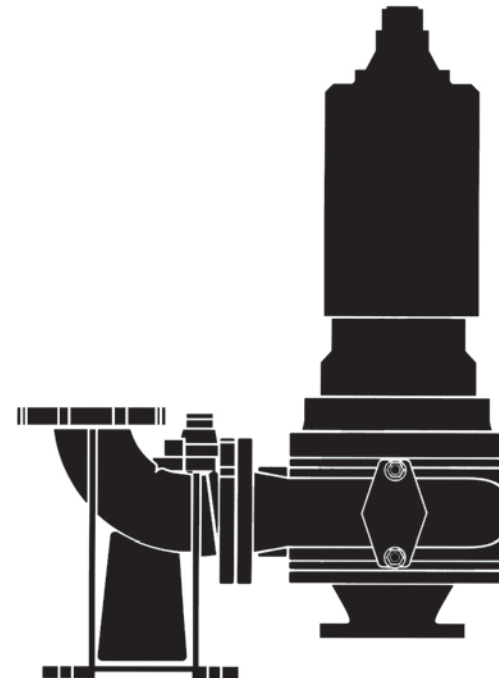

SUBMERSIBLE

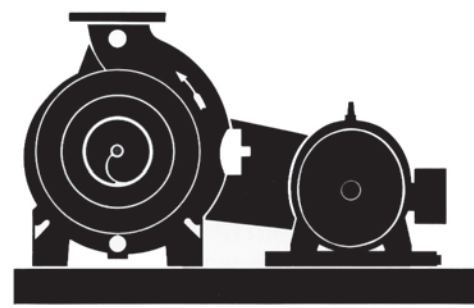

V-BELT

PERFORMANCE RANGE

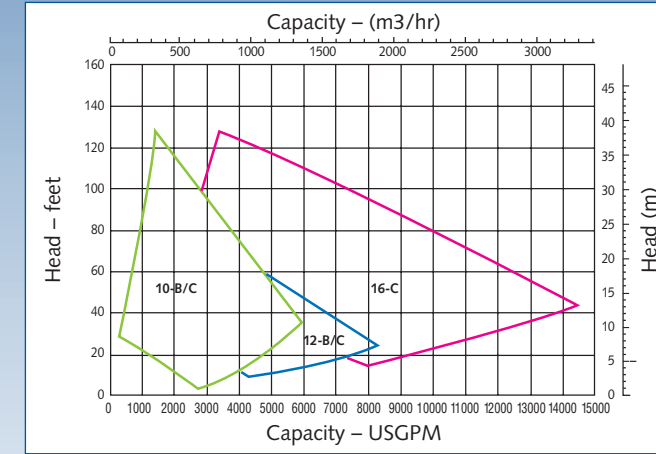
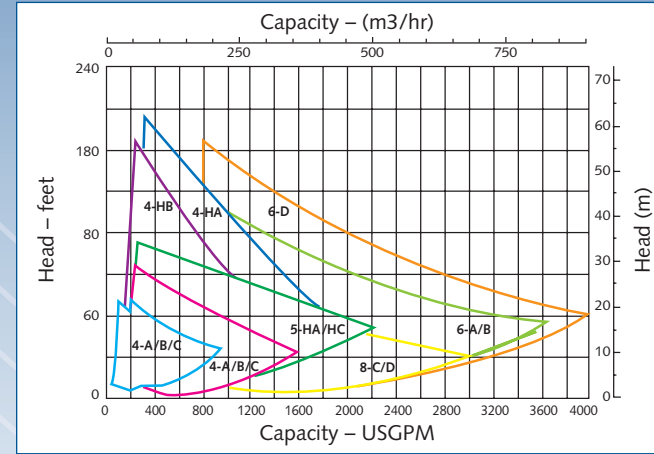

DIMENSIONS

NOT FOR CONSTRUCTION USE.

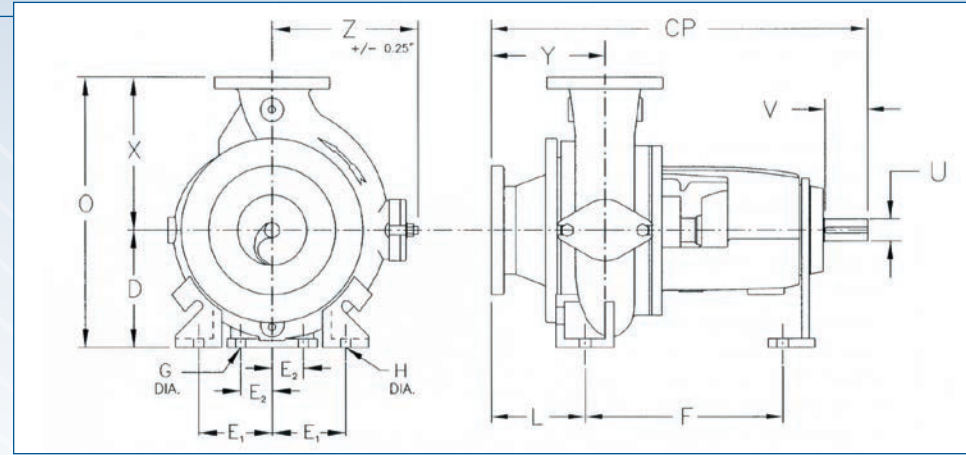

Pump Model	Suction and Discharge size		CP	D	E ₁	E ₂	F	G	H	L	U		O	V	X	Y	X	Wt. Lb	Kg.
	SUCT	DISC									Dia.	Keyway							
XCS4-A/B	4	4	27.4	8.25	5.75	1.75	15.4	.75	.75	5.23	1.38	.31 x .31	18	3	9.75	6.9	10	350	
	100	100	696	210	146	44.5	391	19	19	133	35	7.9 x 7.9	457	77	248	174	254	159	
XCS4-C	4	4	28.9	8.25	5.75	1.75	15.4	.75	.75	6.78	1.38	.31 x .31	19.0	3	10.8	7.75	10.13	360	
	100	100	734	210	146	44.5	391	19	19	166	35	7.9 x 7.9	483	77	273	197	268	164	
XCS4-HA/HB	8	4	38.8	13.5	8.12	6.5	21.75	.62	.87	9.5	2.18	.50 x .50	28	4.25	14.5	9.5	13.2	875	
	200	100	986	343	206	165	553	16	22	241	55	12.7 x 12.7	711	108	368	241	335	398	
XCS5-A/B/C	6	5	32.4	10	6.38	4.38	16.75	.62	.87	8.06	1.88	.50 x .50	23.1	3.7	13.1	9.8	12.6	500	
	150	125	823	254	162	111	425	16	22	205	48	12.7 x 12.7	586	94	333	246	321	227	
XCS5-HA/HC	10	5	43.1	15.5	12.0	6.5	23.7	1.0	1.0	9.0	2.63	.63 x .63	33.6	6	18.1	12.0	17.4	1160	
	250	125	1095	394	305	165	602	25.4	25.4	229	66.8	16 x 16	853	152	460	305	442	2560	
XCS6-A/B/D	8	6	43.6	13.5	8.12	6.5	23.7	.62	.87	10.8	2.18	.50 x .50	29.5	4.25	16	13.5	15.3	900	
	200	150	1107	343	206	165	602	16	22	273	55	12.7 x 12.7	749	108	406	343	389	409	
XCS8-C/D	8	8	33.9	13.5	8.12	4.38	18.7	.62	.87	7.9	1.88	.50 x .50	29.2	3.7	15.7	10.9	16.4	700	
	200	200	861	343	206	111	475	16	22	201	48	12.7 x 12.7	742	94	399	277	417	318	
XCS10-B/C	10	10	44	15.5	12	6.5	23.6	1	1	13.5	2.18	.50 x .50	35.5	4.25	20	13.5	19.92	1400	
	250	250	1118	394	305	165	600	25.4	25.4	343	59.4	12.7 x 12.7	902	108	508	343	506	636	
XCS12-B/C	12	12	50.1	21	13	6.5	24.6	1	1	18	2.63	.63 x .63	48	6	27	18	24.41	1750	
	300	300	1271	533	330	165	625	25.4	25.4	457	66.8	16 x 16	1219	152	686	457	620	795	
XCS16-C	16	16	65	26	18	6.5	33.0	1.25	1.25	20	3.38	.88 x .88	46	7	20	20	30.5	2950	
	400	400	1651	660	457	165	838	32	32	508	86	22.2 x 22.2	1168	178	508	508	775	1340	

Dimensions shown in blue are millimeters, others are in inches.



5 Brigden Gate, Halton Hills, ON L7G 0A3 Tel (905) 693-8595 Fax (905) 693-1452

haywardgordon.com
info@haywardgordon.com



XCS SERIES – SCREW CENTRIFUGAL SOLIDS HANDLING PUMPS



Clog-free pumping action. For large or stringy solids, shear sensitive fluids and delicate materials.



www.haywardgordon.com

XCS SERIES – SCREW CENTRIFUGAL SOLIDS HANDLING PUMPS

INTRODUCTION

The Screw Centrifugal Design

The Hayward Gordon XCS screw centrifugal pump line offers a unique set of advantages for handling thick sludges, large or stringy solids, shear sensitive fluids, and delicate materials.

The XCS open channel screw centrifugal impeller combines gentle, clog-free pumping action with high efficiency and non-overloading characteristics.

For abrasive solids, Hayward Gordon's proven clamp type construction permits the manufacture of wet-end components in wear resistant hard metals.

The primary performance advantages of the XCS design are summarized below:

- High Efficiency (up to 80%)
- Clog-Free Operation
- Abrasion Resistant Construction
- Non-overloading Power Curve
- Low NPSH Requirements
- Gentle Pumping Action
- Positive Suction Flow

FEATURES AND BENEFITS

The XCS Advantages in Detail



High Efficiency

The combined screw-centrifugal action provides smooth flow, low turbulence and minimum hydraulic losses. This translates directly into reduced power costs through lower energy consumption.

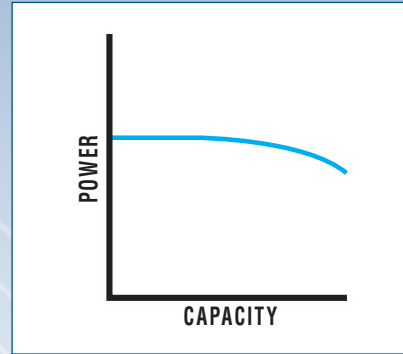

Non-Overloading Power Curve

The power requirements of the Hayward Gordon XCS line are relatively constant when compared to other pump designs. In many cases, the power consumption actually drops with increasing capacity. Motor overloading will not occur when capacity increases due to a drop in head. Capital and operating costs are thereby reduced by not having to purchase and operate oversized motors.

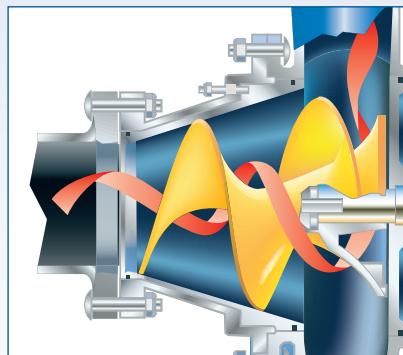

Clog-Free Operation

The large, open channel design allows material to be pumped without restrictions or abrupt changes in direction. There are no exposed blades or edges for solids to catch on. Maintenance due to clogging is virtually eliminated.

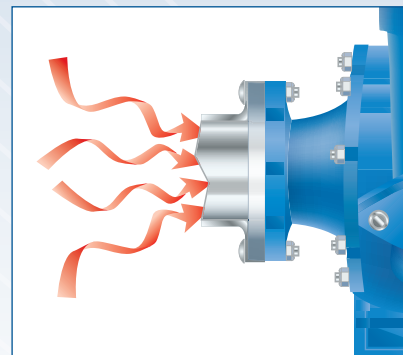

Low NPSH Requirements

The NPSHR (net positive suction head requirement) of Hayward Gordon XCS pumps is extremely low compared to other centrifugal pumps. The suction inducing effect of the impeller's screw section allows the pump to handle thick sludges, hot liquids, and liquids near their vapour pressure without the expense of having to construct an elevated liquid source.



Abrasion Resistant Construction

Hayward Gordon's proven clamp type construction eliminates the need for drilled and tapped holes on wet-end components. This allows construction in a variety of hard metals including Ni-Hard and High Chrome Iron. Also offered is an externally adjustable suction liner that allows convenient adjustment of internal clearances to compensate for wear. These XCS advantages provide long service life in abrasive applications.



Gentle Pumping Action

The XCS's smooth, non-turbulent flow path and large open channel from suction to discharge, allows delicate or shear sensitive material to pass gently through the pump without damage. Fruits, vegetables, flocculants, crystal slurries, and even live fish are easily handled.

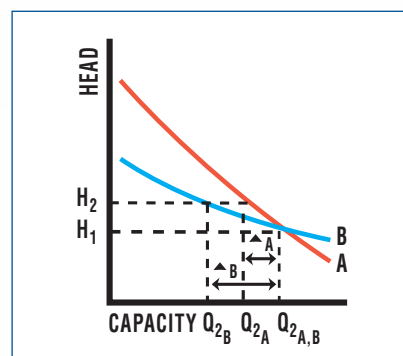

Steep Performance Curve

The steep head-capacity curve means that reserve head is available to keep thick fluids moving even if sludge consistency increases. The positive displacement action of the screw section and low NPSHR means that XCS pumps are capable of inducing the suction required to get these fluids moving.

XCS pump performance represented by Curve A is less sensitive to changes in head than pumps with flatter performance curves (Curve B).

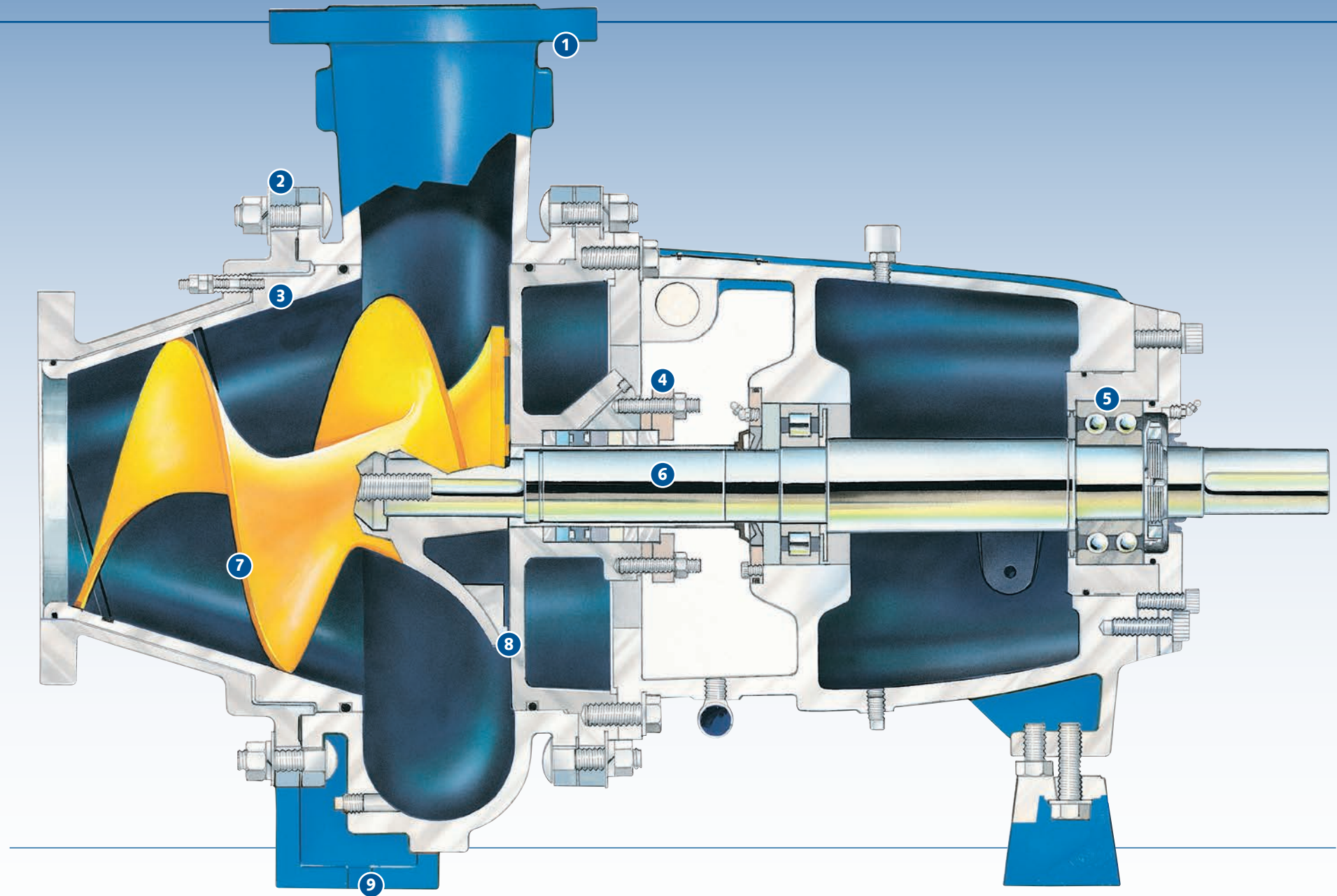

1 Pump end materials of construction include: High Chrome Iron and Ni-Hard for abrasive applications; PLUS Cast Iron, Ductile Iron, 316SS, and other alloys.

2 Clamp type construction eliminates drilled and tapped holes to permit wider use of abrasion resistant hard metals.

3 Optional externally adjustable suction liner for convenient adjustment of impeller clearance.

4 Split bronze gland for easy replacement of packing rings. A wide range of mechanical seals is also available.

5 Oversize grease or oil lubricated bearings for extended service life

6 All shafts are heavy duty design complete with shaft sleeves through the sealing area.

7 Efficient, open-channel, non-clog impeller for smooth passage of large or delicate solids.

8 Impeller pump out vanes or spiral grooves keep solids away from seal area, reduce axial thrust and increase seal/packing life.

9 Back pullout design featuring solid foot-mounted casing, allows servicing of powerframe without disturbing suction or discharge piping.